

# JBC

www.jbctools.com

## INSTRUCTION MANUAL

Product  
website



Download the  
B.IRON app



## B.IRON DUAL 500

Dual Battery-Powered Soldering Station

This manual corresponds to the following references:

**BISS-5QC\*** - without Portable Display  
**BISS-5C\*** - with Portable Display

\*According to the purchased station model and the supplied power cord, suitable for:  
 120V - N. America / Taiwan  
 230V - India / Europe / United Kingdom

## Packing List

The following items are included:



**Charging-Base with Charging-Holders** ..... 1 unit  
 Already assembled:  
 CL0300 Brass Wool for B.IRON  
 Charging-Base.



**B.500 Tool for B.IRON** ..... 2 units  
 Ref. B500-B  
 Includes Tools + B1596 Safety  
 Caps + QB4000 Sealing Plugs +  
 B5050 Grips + fitters.



**C210 Cartridge** ..... 2 units  
 Ref. C210001 (tip ø 0.3 mm)



**B.IRON Display Holder Set 5" to 9"** ..... 1 unit  
 Includes two holding tabs:  
 - For 5"-to-7" displays  
 - For 7"-to-9" displays



**Manual** ..... 1 unit  
 Ref. 0036837



**Quick Start Guide** ..... 1 unit



**Power Cord \*** ..... 1 unit  
 Ref. 0027380 120V - N. America / Taiwan  
 0027381 230V - India  
 0027382 230V - Europe  
 0027378 230V - United Kingdom



**Portable Display 8.6" for B.IRON \*\*** .... 1 unit  
 Ref. PDS-C  
 Includes USB-A to USB-C cable (ref. 0032705)

\* One power cord included according to customer requirements.

\*\* Supplied only in BISS-5C or sold separately.

## Important

Please read this manual and its safety guidelines thoroughly before using the product.



**Note:** Even if the display is turned off, the tool remains operational as long as the batteries are charged, even when the cartridge is removed.

The tool can be manually switched off and on by tapping the tool power button on the display (see page 9).

The tool turns off automatically only under the following conditions:

- The tool is out of the charging holder (without safety cap on) and remains completely still for 5 minutes.
- The tool has the safety cap on and remains completely still for 60 minutes.
- The tool is in the charging holder and the charging base is disconnected from the mains.

## Features and Connections

### B.IRON Display Holder Set 5" to 9"

Can be attached to the back of the B.IRON charging base to mount the display on B.IRON.



# Features and Connections

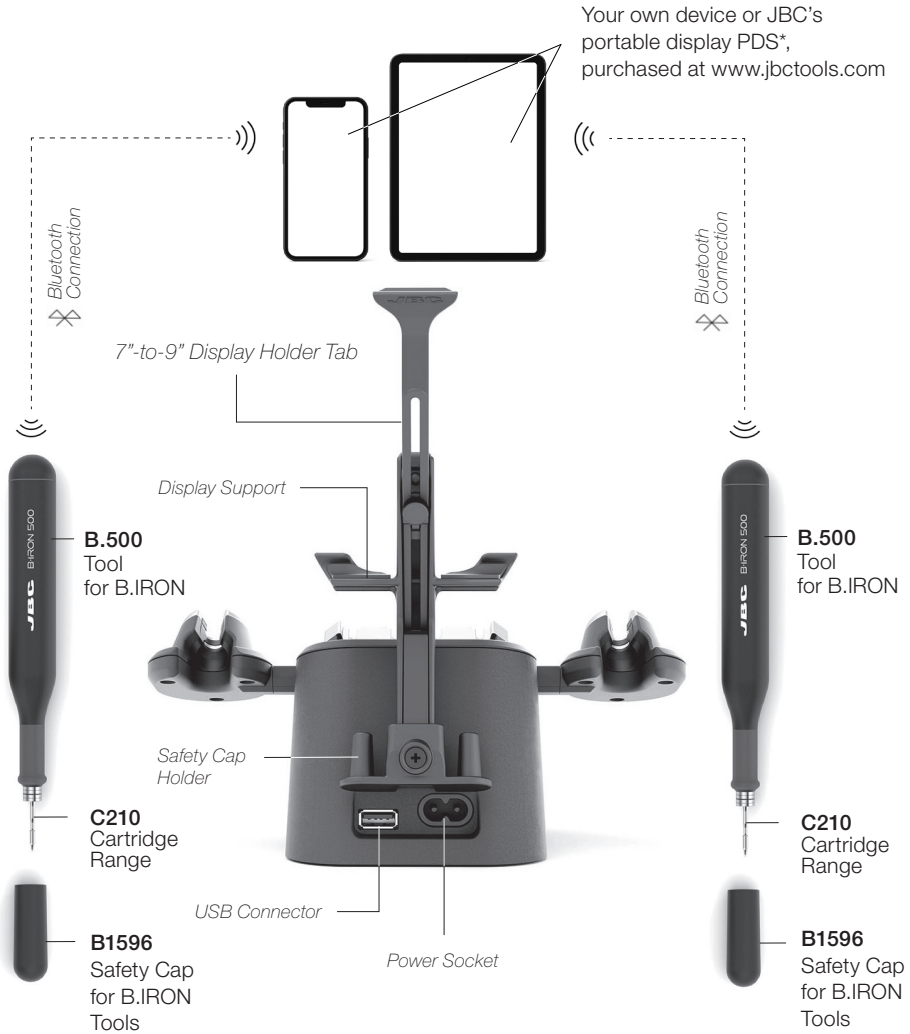

## ESD Safe Connection

**Note:** All B.IRON components comply with CE standards, but the tool by itself is not grounded. Therefore, to comply with ESD regulations, the user of the B.IRON tool must be ESD-compliantly grounded.

JBC offers ESD tablemats, earthing cables, plugs and wristbands. More information at [www.jbctools.com](http://www.jbctools.com).

\* Supplied only in BISS-5C or sold separately.

## Station Setup

### Assemble the Display Holder

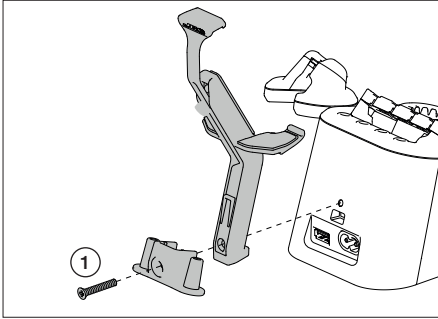

Align the display holder components as shown in the image and screw them to the charging base using the supplied DIN965 screw (1).

### Release the Display Holder's Tab

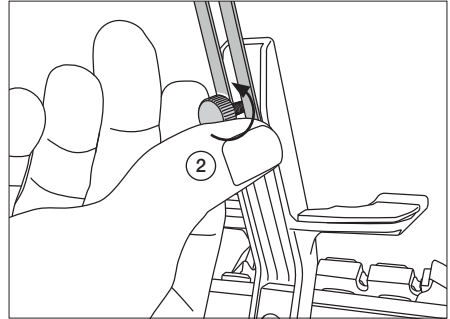

Loosen the fixing knob (2) enough so that the display holder tab can slide along the rear rail.

### Place the Display

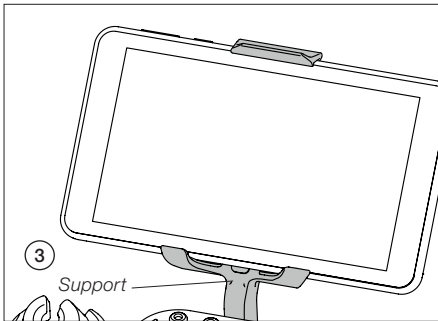

Place the display on the support (3). Adjust the height of the display holder tab and tighten the fixing knob.

### Plug in the Charging Base

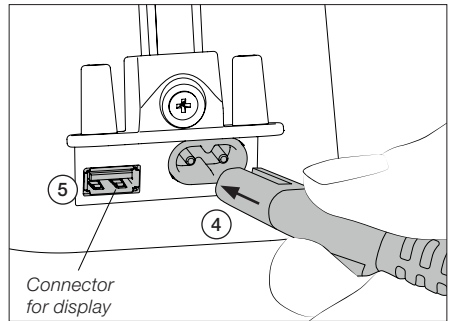

Connect the charging base to the mains (3).

Your display can be connected to the USB port (4) to keep it charging while working.

On your display, open the B.IRON app:



# Tool Connection

1. Make sure that the charging base is connected to the mains.

2. Place the tool on the charging holder to turn it on. **Note:** Charge the tool completely before using it for the first time. A full charge takes:

- 30 min for B.100
- 60 min for B.500
- 30 min for B.NANO
- 45 min for B.TWEEZERS

3. Press the Scan button. The tool must have some battery to appear on the scan.

4. Select the tool or tools you want to connect to the station and press the Connect button.

If your tool does not appear on the list, check that it has some battery (see Status Lightband section) and that it is on, and press the Scan button again.

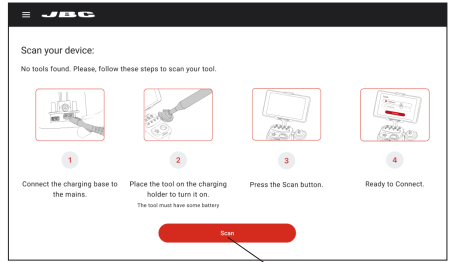

Scan Button

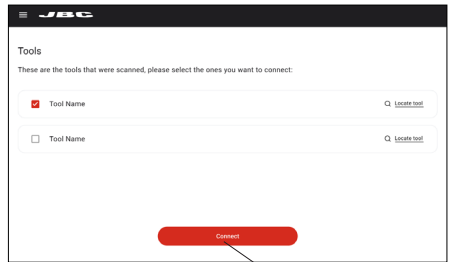

Connect Button

# Status Lightband

The status lightband on the tool indicates its status (see table on the right).



Status Lightband Detail

Color	Tool Status
Green	More than 50% charged
Orange	Between 20% and 50% charged
Red	Less than 20% charged
Flashing green	Charging (more than 50% charged)
Flashing orange	Charging (between 20% and 50% charged)
Flashing red	Charging (less than 20% charged)
No color	Safety cap on the tool and/or power off
Flashing blue	Locate Tool function activated

## Main Screen - Work

The Work tab on the main screen shows a graph of the tip temperature and power supplied to the tip updated in real time. It allows modifying the tool working temperature, checking the battery charge level and turning the tool in use on and off.

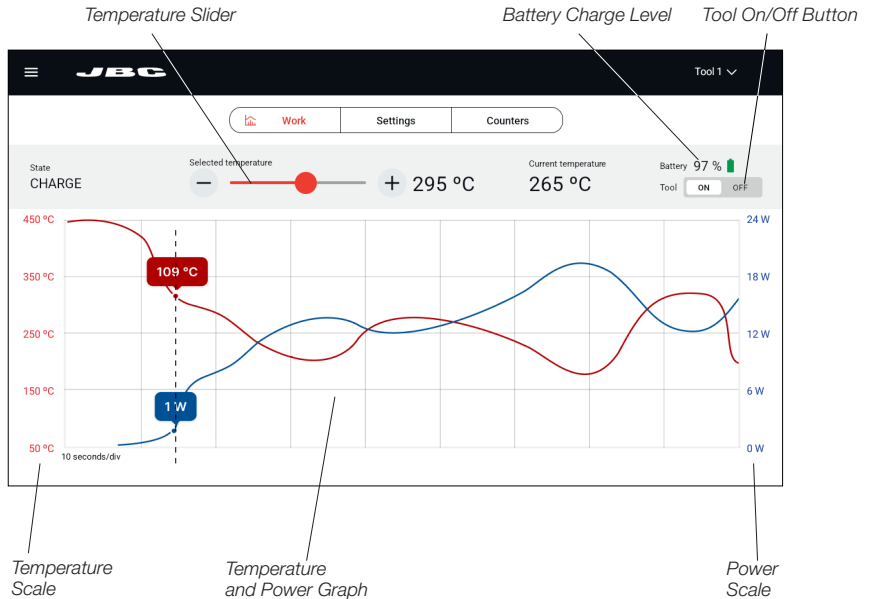

### Graph and Automatic Data Display

The graphs of temperature and supplied power start automatically as soon as the tool is lifted from the charging base.

The temperature/power values can be checked at a certain point of the graph by tapping on the desired position on the display screen.

The graph can be moved to the left and right by swiping the touch screen sideways with one finger.

### Working Temperature Modification

The working temperature can be modified using the temperature slider or the buttons on its sides.

# Main Screen - Work

Active Tool and Tool Selector

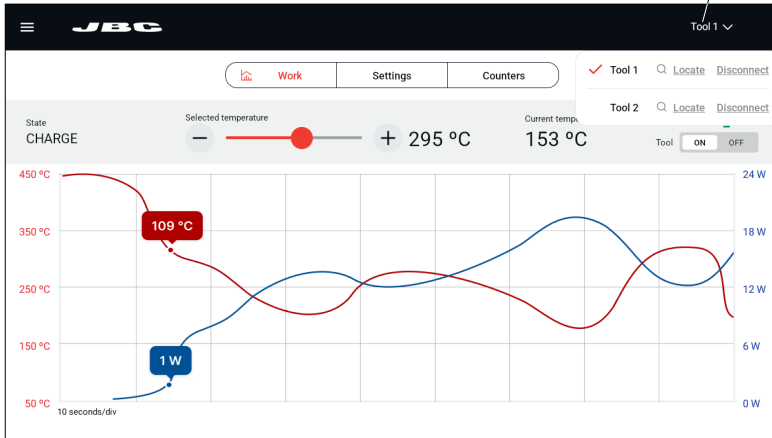

## Stopping Data Display

When the tool is placed in the charging holder or when it enters Hibernation Mode, the data display stops.

The display starts again automatically when the tool is lifted from the tool holder and the graph is automatically displayed again at the point where the previous display stopped, leaving a small gap on the graph between the last registered value and the new starting point.

## Working with Two Tools

When working with two tools, to switch between the two graphs, tap on the tool selector (upper-right corner of the display) and select the desired tool from the drop-down menu.

It is also possible to alternate both graphs by simply lifting one tool or the other from the tool holder. The display will automatically show the graph and information of the tool in use.

## Locate Tool Function

From the tool selector, it is also possible to use the Locate tool function, which illuminates the status lightband of the tool for identification by flashing blue.

## Main Screen - Work

### Auto Turn-Off

The tool turns off automatically in three different cases:

- When the tool (without the tool cap) is laid down and remains completely still in Hibernation Mode for 5 minutes.
- When the tool (with the tool cap on) remains completely still in Hibernation Mode for 60 minutes.
- When the tool is in the charger and the charging base is disconnected from the mains.

### Tool Reactivation

After automatically shutting off, place the tool back in the charging holder to reactivate it.

### Manual Turn Off/On

Besides the “automatic turn-off” feature, the tool can also be manually turned off/on by tapping the Tool On/Off button on the display.

**Note:** If the tool is turned off manually and remains completely still for more than 5 minutes or with its cap on for more than 60 minutes, place it back in the charging holder to reactivate it.

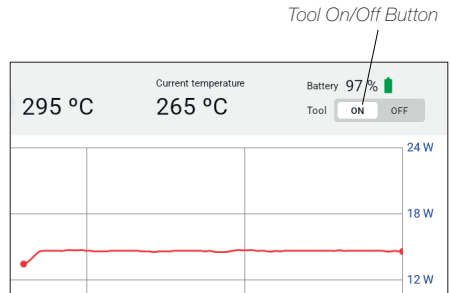

# Main Screen - Work

## Status

The tool can display different statuses:

Status	Caused by	Effect	Solution
Work	Lift an operative tool from the charging holder.	The cartridge heats up to the selected temperature.	N/a
Charge	Place the tool in the charging holder.	The cartridge cools down to room temperature and the battery charges.	N/a
Hibernation	Leave the tool completely stationary out of the charging holder for an adjustable period of time (5 to 15 seconds).	The cartridge cools down to room temperature.	N/a
Cover	Place the safety cap onto the tool.	The cartridge cools down to room temperature and the status lightband turns off. Communication with the station is interrupted.	N/a
Connection lost	The connection between the tool and the station has been interrupted. Possible reasons: the tool has its safety cap on, the tool has been inactive for 5 min., the tool is over 10 m away from the station.	Tool-to-app information exchange interrupted.	If the safety cap is on, remove it. Place the tool in the charging holder if needed. If the safety cap is not on, place the tool in the charging holder.
Off	The tool is turned off.	Cartridge cools down to room temperature.	Turn on the tool by pressing the On/Off button on the main screen.
No cartridge	The tool does not have a cartridge inserted or it is not inserted correctly.	Inoperative tool.	Check that the cartridge is inserted correctly or insert a cartridge.
Shortcircuit	Defective or unusable cartridge inserted.	Inoperative tool.	Replace the cartridge.
Low batt	Battery of the tool nearly depleted.	The tool will turn off soon.	Charge the tool by placing it in the charging holder.

## Main Screen - Settings

The B.IRON app offers an intuitive user interface, which provides quick access to several station parameters:

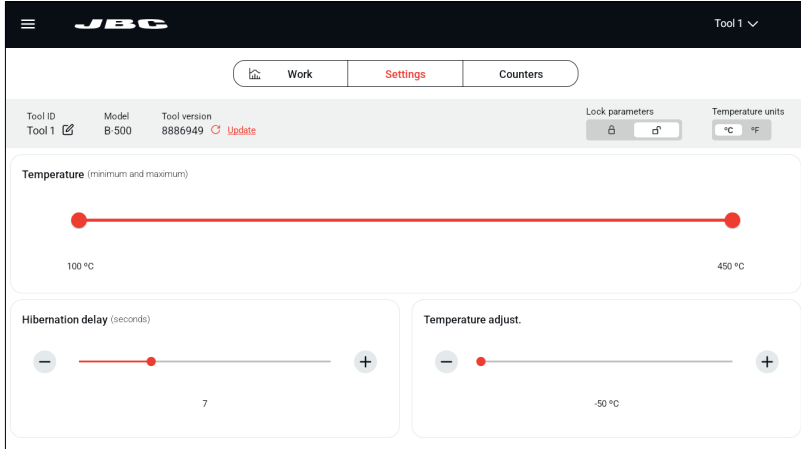

Parameter	Description
Tool ID	Allows modifying the tool identifier.
Lock parameters	Allows locking the parameters of the station using a four-digit code. The default code is 0105, but a new code can be set by simply entering some other four digits of choice when locking the parameters.
Temperature units	Allows changing the units of temperature measurement between degrees Celsius and degrees Fahrenheit.
Temperature	Define the minimum/maximum selectable working temperature.
Hibernation delay	Set the Hibernation delay from 5 to 15 sec. The countdown starts when the tool remains completely stationary out of the charging holder or when placed in the charging holder.
Temperature adjustment	Sets an offset on the selected temperature value.

## Main Screen - Counters

On this tab of the main screen, you can view various counters, such as the time the tool has been active or in hibernation, or the number of times it has been charged or a cartridge has been changed.

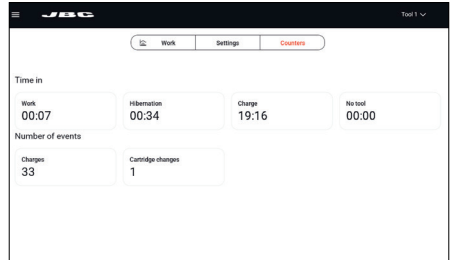

## Menu

### Tools:

Go to the main screen (see section “Main Screen”).

### App Settings:

Configure specific settings for the station, such as language or light/dark theme, update the app version or take a walkthrough on some of the app’s features.

### Documents:

User manuals related to the station or to the tools can be consulted in this section or at JBC’s website: [www.jbctools.com](http://www.jbctools.com).

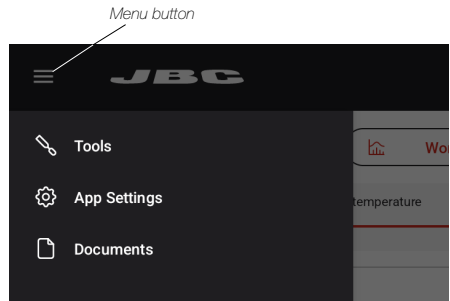

## Operation

Thanks to JBC’s Intelligent Heat Management, the cartridge tip regains temperature extremely quickly.

This allows reducing the tip’s temperature when the device is not in use, resulting in a longer tip lifespan.

When the tool enters Hibernation Mode or the charge status, the tip automatically cools down to room temperature.

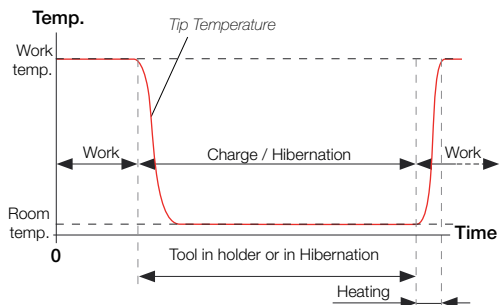

## Safety Cap

### Safe Tool Transportation

Thanks to the tool's safety cap, B.IRON tools can be carried around safely, even with the cartridge inserted.

When the cap is placed onto the tool, the cartridge tip cools down to room temperature.

**Note:** The purpose of the cap is to allow safe transport, not storage.



### Safety Cap Holder

While the tool is in use, the safety cap can be stored on the cap holder located on the back of the charging base.

There is space for two caps.



# Compatible Cartridges

B.500 works with C210 cartridges. Find the model that best suits your soldering needs at [www.jbctools.com](http://www.jbctools.com).

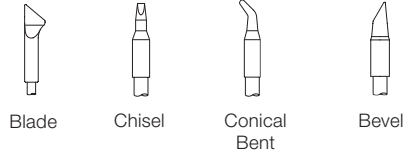

# Cartridge Insertion and Replacement

## Cartridge Extractor

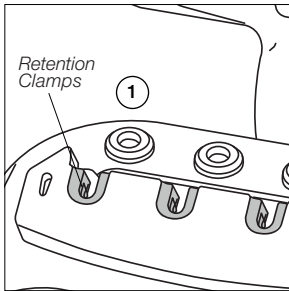

The cartridge extractor allows inserting / changing cartridges safely without switching off the tool. Cartridges are held in place thanks to the retention clamps (1).

The exchanger is suitable for C115 and C210 cartridges.

## C210 Cartridges

The holding area of C210 cartridges goes from the collar of the tip until the cartridge begins to widen (x).



## Cartridge Replacement

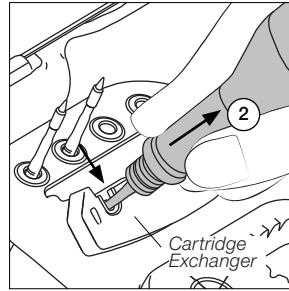

Place the tool with the cartridge over the cartridge exchanger slots and press down (1) until it clicks. To remove the cartridge pull out the tool (2).

To insert a cartridge, carry out the same steps in reverse order.

**Note:** Push the cartridges inside the tool until the reference mark is aligned with the edge of the tool.

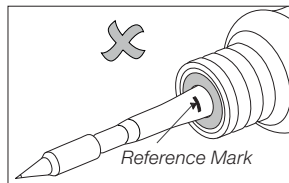

## Cartridge Fixing

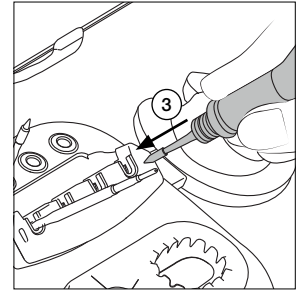

Gently press the tip against the holes on the sides of the cartridge exchanger (3) to ensure that the cartridge is appropriately inserted.

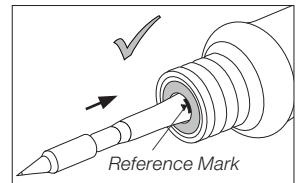

## Wiper and Tip Cleaner

Select the tip cleaning option that best suits your needs and improve the tip thermal transfer.

**CL0301** Wiper for B.IRON Charging-Base includes an anti-splash area that prevents solder particles from splashing onto the working area, keeping the workplace clean.

It also includes a temperature-resistant wiper area for removing excess solder by gently tapping or wiping the cartridge tip on it.

### Tapping

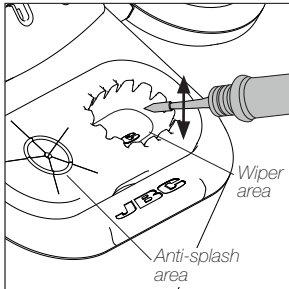

Tap gently to remove excess solder.

### Wiping

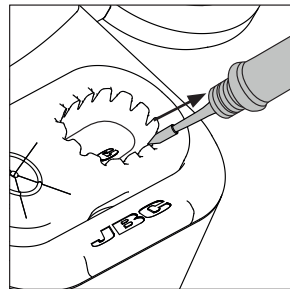

Use the slots to remove remaining particles.

### Brass Wool *(inside)*

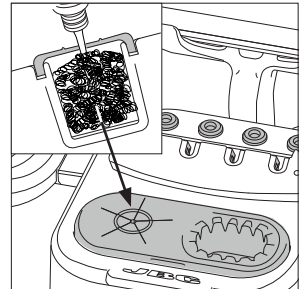

**CL0300** Brass Wool is a very effective cleaning method. It leaves a small layer of solder on the tip, preventing oxidation between cleaning and rewetting.

**Note:** If the tip is very dirty, JBC recommends cleaning it first with the wiper to remove excess solder and then with the brass wool.

## Replacing Brass Wool

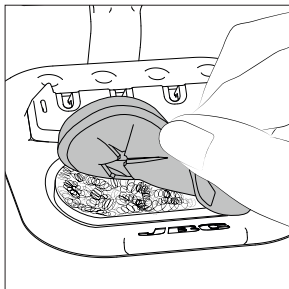

Lift the wiper membrane by using the recess on the edge. Remove the wiper and replace the brass wool with a new one. Make sure that the brass wool is on the far left and that there is space for the wiper on the right.

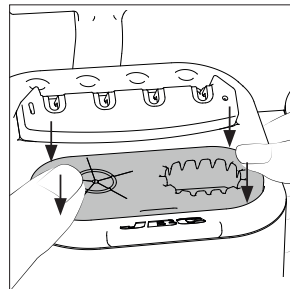

Press the wiper membrane down at the 4 corners until you feel it click into place. Make sure that the wiper membrane is inserted correctly all the way around.

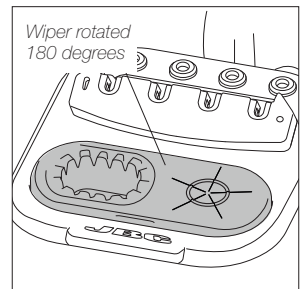

**Note:** The brass wool and the wiper positions can be reversed by rotating the anti-splash membrane 180 degrees.

# App Installation

On your **smartphone or tablet** (*Android / iOS*), go to the App Store/Play Store and search for “JBC B.IRON” on the search bar.

On **JBC’s portable display** (*Android*), the B.IRON app is already installed.

**Note:** Internet connection is required to download the app from the App Store or Google Play.

Alternatively, scan these QR codes to access the B.IRON app website:



The image shows two QR codes side-by-side. The left one is for the App Store, with the text 'Download on the App Store' above it. The right one is for Google Play, with the text 'GET IT ON Google play' above it.

## For displays without Internet connection

*(Android only)*

Download JBC’s installer to another device with an Internet connection from JBC’s website: <https://www.jbctools.com/jbcsoftware.html>.



Then, connect the display to the device with the installer and enable file transfer on the USB preferences of the display (swipe down from the top of the screen and tap on the notification from Android System).

Copy the installer to the internal storage of the display on Files > Internal storage > JBC (create folder if non-existent). Access the folder named JBC on the internal storage of the display and run the installer.

# App Versions

Make sure that the required app version is installed on the display (tablet or smartphone) for compatibility reasons:

- B.100, B.500 and B.NANO require app versions **1.6** or higher.
- B.TWEEZERS requires app versions **1.7** or higher.

# App Update

## Display with Internet connection *(Android / iOS)*

Update through “App Settings” on the main menu of the app, Google Play (*Android*) or App Store (*iOS*).

## Display without Internet connection *(Android)*

Download JBC’s installer to another device with an Internet connection from JBC’s website: <https://www.jbctools.com/jbcsoftware.html>.



Then, connect the display to the device with the installer and enable file transfer on the USB preferences of the display (swipe down from the top of the screen and tap on the notification from Android System).

Copy the installer to the internal storage of the display on Files > Internal storage > JBC (create folder if non-existent). Access the folder named JBC on the internal storage of the display and run the installer. After the installer is completed, the app will be updated to the latest version.

## Downloading the Tool Firmware Update File

### Display with Internet connection:

Download the firmware update file to the display used with B.IRON from <https://www.jbctools.com/jbcsoftware.html>. Go to the internal folder and unzip the downloaded file.

### Display without Internet connection:

Download the firmware update file to another device with an Internet connection from JBC's website: <https://www.jbctools.com/jbcsoftware.html> and unzip the downloaded file.

Then do as described in the table.

Android devices	iOS devices
Transfer the unzipped files from the internet-connected device to the device used with B.IRON and place them in the following path/folder:	
\Internal shared storage\Android\data\com.jbctools.jbcbiron\files	Files > On my iPad > JBC B.iron 

## Executing the Tool Firmware Update File

Tool firmware updates are not executed automatically; they must be carried out by the user.

On the display you are using with B.IRON, and with the latest app version installed, access the B.IRON app: 

Connect the tool you want to update. Then, on the Settings tab of the main screen, tap "Update" (1).

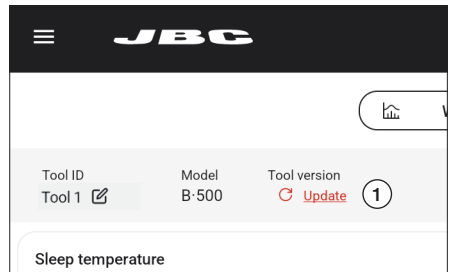

## Executing the Tool Firmware Update File *(continuation)*

If the downloaded tool firmware update file contains a more recent version than the one already installed, the current and new version are displayed (2). Tap “Install” to start the update (3).

The update process takes about 10 minutes.

The B.IRON status lightband continuously changes its color during the update process.

Once the update is complete, the pop-up message “The tool version has been updated correctly” appears on the screen.

If “No new version available” is displayed, no update is possible or required.

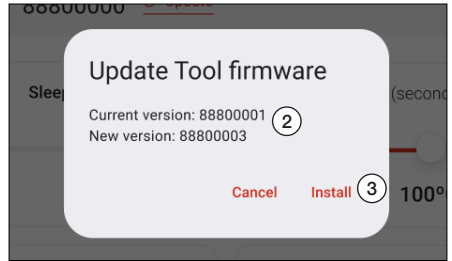

## Accessories

### B.IRON Display Holder 10" to 13"

Ref. 0031246

In addition to the display holder supplied with the B.IRON station, JBC offers a holder for tablet sizes between 10" and 13".

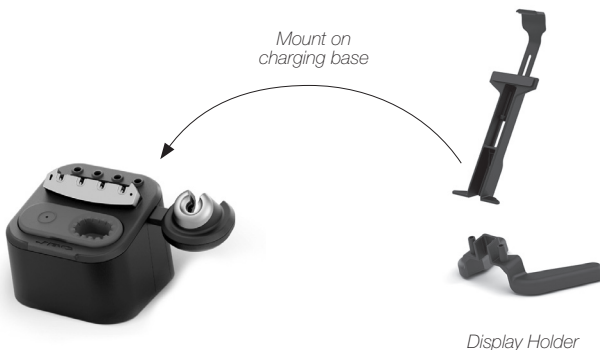

## Accessories *(continuation)*

### Soldering Tools for B.IRON Stations

#### **B.NANO\***

Nano Tool for B.IRON



Ergonomic and lightweight soldering tool. Designed for use in labs and high-precision soldering in hard-to-reach areas.

Works with C115 Cartridges.

#### **B.TWEEZERS\***

Nano Tweezers for B.IRON



Powerful and efficient soldering tweezers. Designed for use in labs and soldering rework jobs.

Works with C115 Cartridges.

#### **B.100\***

Light Tool for B.IRON



Ergonomic and lightweight soldering tool. Designed for use in labs and individual soldering jobs.

Works with C210 Cartridges.

#### **B.500\***

Tool for B.IRON



Powerful and efficient soldering tool. Designed for use in production and intensive soldering jobs.

Works with C210 Cartridges.

*\* Cartridges not included.*

*To charge the tools, a B.IRON charging base or station is needed.*

*Required app version: For B.100, B.500 and B.NANO, 1.6 or higher and for B.TWEEZERS, 1.7 or higher.*

# Accessories *(continuation)*

## Tool Expansion Kits for B.IRON Stations

### **B.NANO K\*** Nano Tool Expansion Kit

This kit allows extending B.IRON stations with B.NANO Tool.

Works with C115 Cartridges.



### **B.TWEEZERS K\*** Nano Tweezer Expansion Kit

This kit allows upgrading B.IRON stations to a rework station by adding B.TWEEZERS.

Works with C115 Cartridges.



### **B.100 K\*** Light Tool Expansion Kit

This kit allows extending B.IRON stations with B.100 Light Tool.

Works with C210 Cartridges.



### **B.500 K\*** Tool Expansion Kit

This kit allows extending B.IRON stations by adding B.500 Tool.

Works with C210 Cartridges.



\* Cartridges not included.

To charge the tools, a B.IRON charging base or station is needed.

Required app version: For B.100, B.500 and B.NANO, 1.6 or higher and for B.TWEEZERS, 1.7 or higher.

## Maintenance - B.IRON Tools

### Replacing Soft Foam Grips - B1510 (B.100, B.NANO, B.500-A) / B5050 (B.500-B)

#### Inserting Fitters

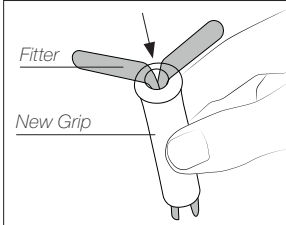

Insert the fitters into the new grip.

#### Assembling Grips

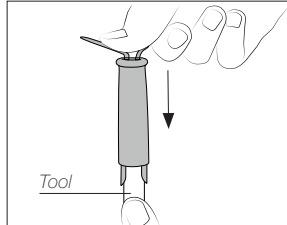

Push the grip with the fitters onto the tool.

#### Removing Fitters

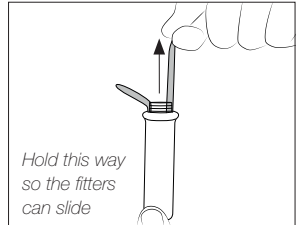

To remove the fitters, hold the grip and pull the fitters out. Use pliers if necessary.

## Sealing Plugs

The sealing plug prevents undesirable flux vapors or particles from entering the tool and its usage is highly recommended. If the sealing plug is not used, this can lead to incorrect cartridge contact and may render the tool unusable.

**Note:** Check the condition of the plug periodically and replace it as soon as wear or cracking is detected.



Before replacing the sealing plug, disconnect the tool from the station and make sure the device has cooled down.

Tool	Sealing Plug Ref.
B.NANO	OB5000*
B.100 and B.500	OB4000*

\* Each ref. comes with 10 sealing plugs

### Replacing Sealing Plug for B.100 & B.500 Tools - OB4000 *comes with 10 sealing plugs*

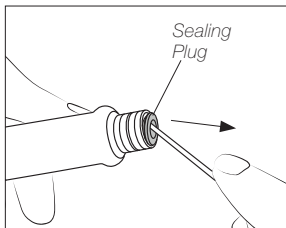

Introduce a small shaft or screwdriver, not deeper than 8 mm, lift and pull the sealing plug. Never use a cartridge to do this operation.

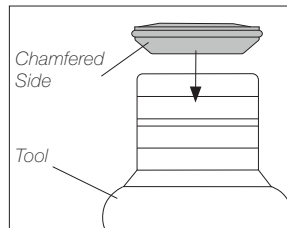

Push the sealing plug inside the tool.

**Note:** The chamfered side of the sealing plug has to be positioned towards the tool.

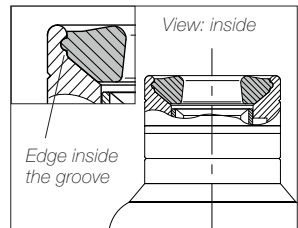

Make sure the sealing plug is placed correctly.

The edge of the sealing plug must rest in the groove of the tool bushing.

# Maintenance

Before carrying out maintenance, always extract the cartridge from the tool and disconnect the charging base from the mains. Allow the equipment to cool down.

- Use a damp cloth to clean the casing and the tool. Alcohol can only be used to clean the metal parts.
- Periodically check that the metal parts of the tool and charging holder are clean so that the charging works properly.
- Keep the tip surface clean and tinned prior to storage in order to avoid tip oxidation. Rusty and dirty surfaces reduce heat transfer to the solder joint.
- Do not use liquids such as alcohol, thinner or benzene to clean the portable display.
- Repairs should only be performed by a JBC authorized technical service.



# Safety - Battery

 **It is imperative to follow safety guidelines to prevent electric shock, injury, fire or explosion.**

- **Caution:** This product contains lithium-ion batteries. Mishandling or improper use may result in fire, explosion, or personal injury.
- Always use the provided charger. Do not use damaged chargers or batteries.
- Never attempt to disassemble or modify the batteries or the product. Doing so may lead to electric shock, fire, or damage to the product.
- In the event of damage, leakage, or overheating of the batteries, discontinue use immediately and contact customer support or JBC technical service facility.
- Dispose of devices with batteries inside, responsibly according to regulations. They must be disposed of in accordance with local regulations so that they can be recycled.
- Do not throw devices with batteries into household waste and do not dispose of them in fire or water.

## Safety



**It is imperative to follow safety guidelines to prevent electric shock, injury, fire or explosion.**

- Do not use the units for any purpose other than soldering or rework. Incorrect use may cause a fire.
- The power cord must be plugged into approved bases. When unplugging it, hold the plug, not the wire.
- Do not attempt to dismantle or open the housing of the tool as it may cause damage.
- Do not work on electrically live parts.
- The tool should be placed in the charging holder when not in use in order to charge the batteries.
- The soldering tip, the metal part of the tool and the charging holder may still be hot even when the station is turned off.
- Do not leave the tool unattended when it is on.
- Avoid flux coming into contact with skin or eyes to prevent irritation.
- Be careful with the fumes produced when soldering.
- Keep your workplace clean and tidy. Wear appropriate protection glasses and gloves when working to avoid personal harm.
- Utmost care must be taken with liquid tin waste, which can cause burns.
- This appliance can be used by children over the age of eight and also persons with reduced physical, sensory or mental capabilities or lack of experience provided that they have been given adequate supervision or instruction concerning the use of the appliance and understand the hazards involved. Children must not play with the appliance.
- Maintenance must not be carried out by children unless supervised.
- Do not expose the portable display to high temperatures, humidity or dust. Avoid direct sunlight.
- Do not drop the portable display or the tool, as it may cause damage or malfunction.
- Do not disconnect your device when it is in file transfer mode.
- Do not use the portable display in places where wireless communications are restricted.







## Specifications

### **B.IRON DUAL 500**

#### **Dual Battery-Powered Soldering Station**

Ref. **BISS-5QC** - without Portable Display

Ref. **BISS-5C** - with Portable Display

#### **Charging-Base**

- Input: 100 V - 240 V 50 / 60 Hz
- Nominal Power: 40 W
- USB Output: 5 V / 1000 mA

#### **B.500 Tool**

- Peak Power (Tool): 24 W
- Battery: Li-Ion 7.4 V / 750 mAh
- Charge Time: 60 minutes
- Selectable Temperature: 100 - 450 °C / 210 - 840 °F
- Idle Temp. Stability (still air): ±1.5 °C / ±3 °F
- Temp. Accuracy: ±3 % (using reference cartridge)
- Connections: Bluetooth Low Energy (BLE)
- Ambient Operating Temp.: 10 - 50 °C / 50 - 122 °F
- Meets: ANSI/ESD S20.20
- Tool Weight: 70 g / 0.154 lb

#### **Portable Display 8.6"**

- Display Dimensions: 8.68 inches
- Operating System: Android 14
- Connectivity: Bluetooth 5.0
- ROM Storage Capacity: 64 GB
- RAM System Memory: 4 GB
- Battery: Li-Ion 3.7 V / 5000 mAh
- Charging Current: 5 V / 2 A

Ref. **BISS-5QC** without Portable Display:

- Total Net Weight: 1.70 kg / 3.75 lb
- Total Package Dimensions/Weight:  
(L x W x H) 225 x 223 x 160 mm / 2.30 kg  
8.86 x 8.78 x 6.30 in / 5.07 lb

Ref. **BISS-5C** with Portable Display:

- Total Net Weight: 2.23 kg / 4.92 lb
- Total Package Dimensions/Weight:  
(L x W x H) 265 x 223 x 160 mm / 2.85 kg  
10.43 x 8.78 x 6.30 in / 6.28 lb

Complies with CE standards.

ESD Safe (to comply with ESD requirements, see page 4).

# JBC

---

## Warranty

JBC's 2 year warranty covers this equipment against all manufacturing defects, including the replacement of defective parts and labor.

Warranty does not cover product wear or misuse.

In order for the warranty to be valid, equipment must be returned, postage paid, to the dealer where it was purchased.

**Get 1 extra year JBC warranty by registering here:**  
**<https://www.jbctools.com/productregistration/>**  
**within 30 days of purchase.**

If you register, you will receive e-mail notifications about new software updates for your registered product.

---



This product should not be thrown in the garbage.

In accordance with the European directive 2012/19/EU, electronic equipment at the end of its life must be collected and returned to an authorized recycling facility.

CE EAC UK  
CA

[www.jbctools.com](http://www.jbctools.com)

0036637-120326